



Thermal Spray Shape Deposition

L.E. Weiss, F.B. Prinz, D.A. Adams, and D.P. Siewiorek

This paper describes a new spray-forming process based on thermal spray shape deposition. Shape deposition processes build three-dimensional shapes by incremental material buildup of thin, planar cross-sectional layers. These processes do not require preformed mandrels and can directly build three-dimensional structures of arbitrary geometric complexity. The basis for the thermal spray approach is to spray each layer using a disposable mask that has the shape of the current cross section. Masks can be produced from paper rolls, for example, with a CO₂ laser. In addition to applications for rapid prototyping, this approach makes possible the fabrication of composite structures and integrated electronic/mechanical assemblies that are not feasible with conventional manufacturing technologies.

1. Introduction

To successfully compete in current global markets requires the rapid development and manufacture of bold new designs to respond to changing market demands. Success requires innovative manufacturing activities. One such activity is rapid prototyping. To rapidly make prototype shapes directly from computer-aided design (CAD) models, several new technologies have been developed based on shape deposition processing. Shape deposition processes build parts by incremental material buildup of thin 2½-dimensional layers. A 2½-dimensional shape means a three-dimensional surface with an associated uniform thickness. One broad class of the shape deposition processes uses planar cross sections with the growing structure supported by solid sacrificial layers in complementary shapes (Fig. 1). The cross-sectional descriptions are generated by "slicing"

three-dimensional computer representations into slices that may vary in thickness.^[1] Several alternative deposition materials and processes are available for building the object, including selective laser sintering, three-dimensional printing, laminated object manufacturing, and solid ground curing (Table 1).^[2,3]

A principal advantage of the shape deposition approach versus conventional computer numerically controlled (CNC) machining is the ease and speed with which one can go from part design to part fabrication within a computer-aided design/computer-aided manufacturing (CAD/CAM) environment. Planning for CNC machining operations involves several complex steps, including reasoning about three-dimensional geometries, specification and design of part-specific fixturing, and tooling selection. CNC machining also requires highly skilled, experienced labor.

In contrast, the shape deposition processes operate on simple planar geometries that do not require part-specific fixturing or tooling information. The planning and execution effort for shape deposition is essentially independent of part complexity. Operating the shape deposition apparatus also requires minimal human intervention. The part designer can even personally operate this equipment. The parts created with the available shape deposition processes have been built from plastic, ceramic, paper, or wax materials. Although these parts typically do not possess the

Key Words: CAD/CAM, Mask and Deposit (MD*) process, net shaping, robotic manipulation, spray forming

L.E. Weiss, F.B. Prinz, D.A. Adams, and D.P. Siewiorek, The Robotics Institute and the Engineering Design Research Center, Carnegie Mellon University, Pittsburgh, Pennsylvania.

Table 1 Shape Deposition Systems

Process name	Manufacturer	Current materials	Process	Solid support structure
Selective laser sintering	D.I.M. Corp. 1611 Headway Circle Building 2 Austin, TX 78754	Polycarbonate, investment casting, wax, PVC, ABS, nylon	Rollout the heat-fusible powder, then selectively sinter it with a CO ₂ laser	Unsintered powder
Laminated object manufacturing	Helisys, Inc. 2750 Oregon Court Building M-10 Torrance, CA 90503	Paper, polyester	Compress adhesive-coated or impregnated laminate with a hot roller, then cut borders with a CO ₂ laser	Scored laminate
Solid ground curing	Cubital America Inc. 1307 Allen Drive Suite F Troy, MI 48083	Acrylics	Cure the sprayed resin by exposure to UV light through a programmable optical mask, then mill z-axis to desired thickness	Wax
Three-dimensional printing	Soligen 19329 Bryant St. Northridge, CA 91324	Ceramics	Roll out the bindable powder and selectively bind it using ink jet printing to deposit the binder	Unbound powder

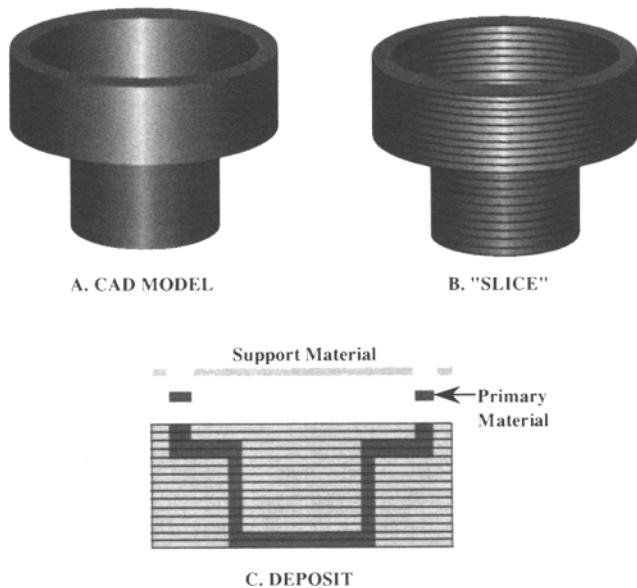

Figure 1 Shape deposition process.

mechanical properties of engineering materials, they are useful for several prototyping applications.^[3] Plastic shapes can be used for form/function/fit testing and as patterns for making “soft” tooling such as sprayed metal dies.^[1] Metal parts can be made from wax or ceramic shapes by investment casting or direct casting, respectively. For these reasons, shape deposition is useful for CAD-driven, rapid prototyping applications.

The ability to create quality metal parts directly by shape deposition remains a challenge. Although the direct fabrication of metal parts is being explored using both selective laser sintering and three-dimensional printing, the resulting porosity remains excessive. Metal deposition using weld-based approaches has superior material properties, but has had severe geometric limitations.^[4] Metal deposition methods based on narrow-beam deposition processes, such as those using ink jet mechanisms, have been suggested to scan each layer; however, porosity, resolution, and support material issues have not been addressed.

Creating three-dimensional shapes by thermal spraying has been widely investigated.^[5] Such spray forming, however, requires preformed mandrels or patterns and is limited to creating shell-like 2½-dimensional structures. Thermal spraying might be used in a shape deposition process by using a well-defined narrow-beam spray, with a well controlled deposition rate, to scan and to build each layer to the desired thickness. Although thermal spray methods would yield good material properties and could deposit a wide range of materials, including composites, they have been dismissed due to the relatively large divergence of the spray beam.^[6] The authors experimented with various aperture techniques to focus arc-sprayed beams, but found these to be unreliable (*i.e.*, the aperture quickly clogs) and inefficient (*i.e.*, scanning time and material waste).

As an alternative approach to narrow-beam deposition, this paper describes a thermal spray shape deposition process based on a masking method to shape each layer accurately. This process is called MD* (MD star), which signifies to recursively Mask

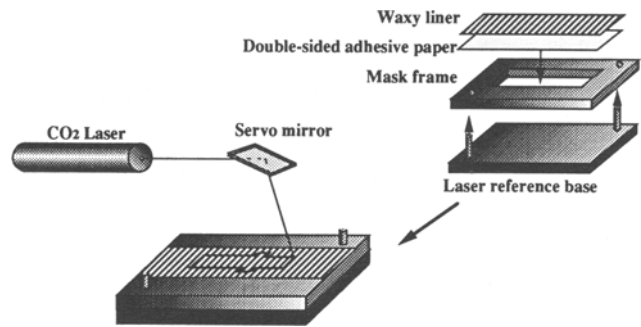

Figure 2 Mask cutting cell.

and Deposit.^[7] MD* has the potential to go beyond rapid prototyping applications by also addressing another current manufacturing challenge: The need to develop more robust processes for forming and joining composite structures. Although the variety of material properties of composites dramatically expands the possibilities for new product designers, current composite manufacturing technologies severely limit the possible geometries. Not only does a thermal spray shape deposition approach have the potential to create dense composite and laminate structures of arbitrary geometric complexity, but masking also facilitates selective material deposition, and different regions within a layer can be composed of different materials. For example, integrated electronic/mechanical assemblies, such as encapsulated computer packages with embedded electronics, are feasible.

Section 2 describes a semiautomated implementation of MD*, which incorporates laser-based mask cutting and robotic spraying. Several complexly shaped zinc artifacts have been fabricated with this system to demonstrate the feasibility of the MD* approach. Section 3 discusses process issues for spraying more demanding materials such as steel, whereas Section 4 proposes a fully automated system configuration. Section 5 describes how MD* could be used to build integrated multimaterial assemblies such as computer packages with embedded electronics.

2. The MD* Process

MD* is a new spray forming process based on shape deposition, in which parts are manufactured by successively spraying cross-sectional layers. Each layer may contain several different materials. With the MD* process, the geometry of a part is not constrained by the manufacturing process, and the shape and material composition can be changed continuously within a part. To create a part, its CAD geometric model is first “sliced” into cross-sectional layers. Each layer is typically 0.025 to 0.125 mm (0.001 to 0.005 in.) thick. For each material in a layer, a disposable mask is made that exposes the area where that material is to occur. The mask is placed on the top layer of the growing part shape, and a robotically manipulated thermal spray gun traverses the areas exposed by the mask. Masks made from paper stock, for example, can be cut with a CO₂ laser. The diameter of the focused laser beam sets the minimum feature size that can be

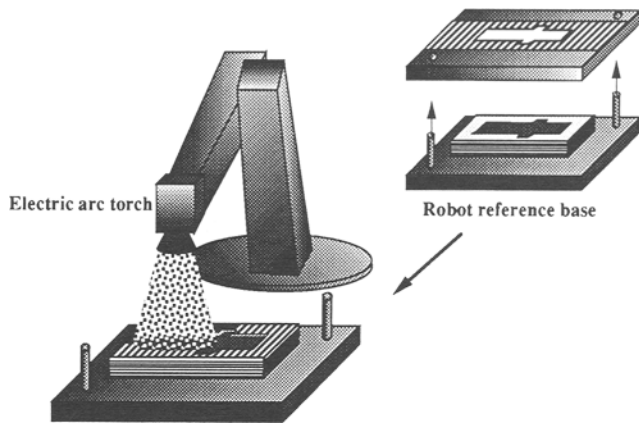

Figure 3 Thermal spray cell.

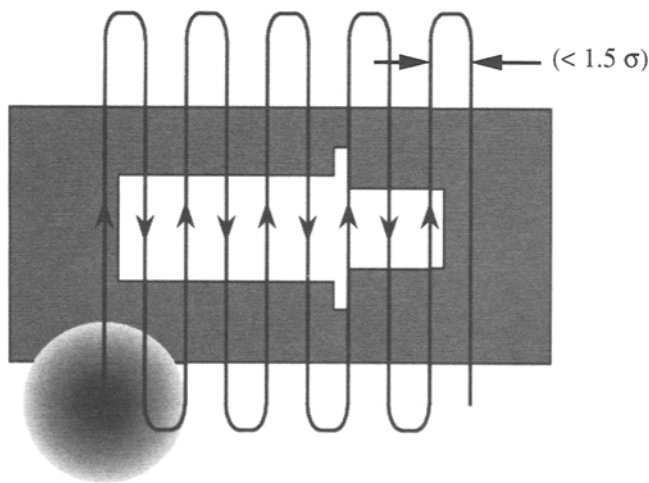

Figure 4 Spraying trajectory, where σ is the standard deviation of the spray pattern. See text for more detail.

created. Several alternative strategies are feasible for creating support structures. One approach, which is described below, retains a part of the mask as the support structure. A second approach, which is discussed in the next section, is more versatile and sprays the support material in a separate operation.

A semiautomated MD* system has been constructed to investigate the feasibility of the MD* process. The system consists of two separate cells, including a laser-based mask cutting cell and a robotic thermal spray cell. Masks are manually transferred between cells. The mask cutting cell, shown in Fig. 2, incorporates a 22-W CO₂ laser focused to a 0.100-mm (0.004-in.) spot size. The laser beam is guided by a set of servo-controlled, galvanometric mirrors. The CAD tools used to automatically slice objects into cross sections and to generate the laser beam trajectories to cut each cross section are described in Ref 8. Masking material is double-sided adhesive paper tape, supplied in roll form, with a waxy paper liner adhered to one side of the tape. The thermal spray cell, as depicted in Fig. 3, incorporates a GMF

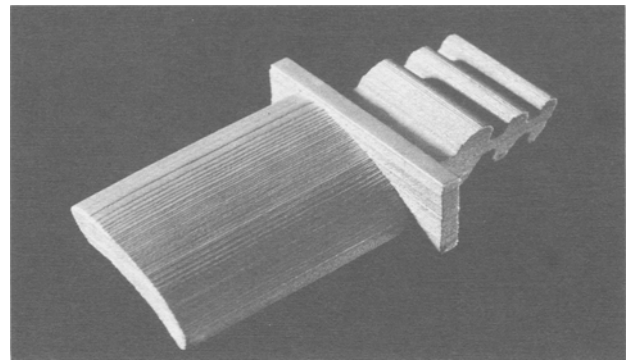

Figure 5 Sprayed zinc turbine blade shape.

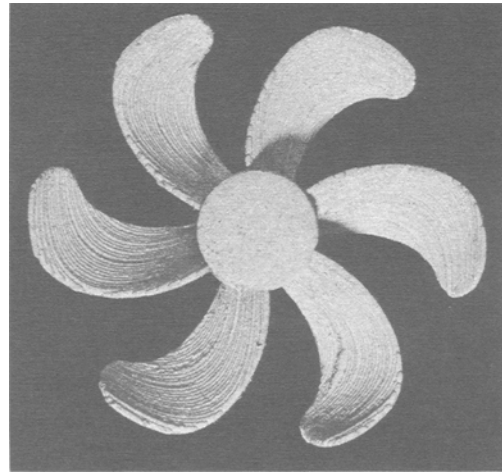

Figure 6 Sprayed zinc fan blade shape.

S-700 robot that manipulates a two-wire electric arc torch. Robot motion control, which is described in detail in Ref 9, maximizes the uniformity of the flat sprayed layers deposited. Spraying includes a calibration procedure to orient the spray torch to maximize the symmetry of the deposited material. Each mask is then sprayed as shown in Fig. 4, where σ is the standard deviation of the distribution determined in the calibration procedure described in Ref 9. With this method, flat surfaces can be deposited with the resulting standard deviation from the mean thickness ranging from 20 to 30 μm .

The sequence of operations for building a complete shape is as follows. The mask material, including the wax paper liner, is manually placed on a mask frame. The tape sticks to the frame by means of the adhesive backing. The frame is located within the laser cutting cell by placing it on a fixed laser reference base using alignment pins. The laser cuts through both the adhesive paper and liner layers, forming a mask. The mask/frame is then removed from the laser cell and placed in the spray cell. The mask is placed on the previously deposited layer by positioning the frame on a fixed "robot" reference base. A rectangular border, as defined by the opening in the frame, is manually cut into the mask opening to permit removal of the frame (and excess

mask material) before proceeding. The robot sprays metal over the mask of a depth equal to the thickness of the adhesive paper, that is, 0.100 mm (0.004 in.). The waxy liner is removed, and a complete layer consisting of paper and metal remains in place.

To complete the process, the steps described above are repeated for each layer. The completed metal part is removed from the paper support structure by peeling and cutting the paper support away.

Several parts have been fabricated in zinc, including the turbine and fan blade shapes shown in Fig. 5 and 6, to demonstrate the capability of this process to produce geometrically complex objects. The turbine and fan blades consist of 162 and 52 layers, respectively; each layer is 0.100 mm (0.004 in.) thick. A problem that was encountered during the fabrication of these parts was the formation of small burrs around the border of the masks. The burring resulted from material buildup in the corner formed by the mask wall and the substrate surface. The burring was accentuated by the relatively large divergence of the spray pattern for the torch used in these experiments. Burrs were removed manually with a razor blade. Each layer took approximately 6 min to build including mask cutting, mask transfer, spraying, mask removal, and deburring. In practice, burr formation could be minimized by using a torch with a narrower beam divergence and by spraying thinner layers. Any residual burrs could easily be removed by an automated system.

The system described in this section demonstrates the feasibility of the MD* approach. This zinc-base, semiautomated system, however, has several limitations. A completely automated system is required not only for practicality, but also for shortening layer building cycle times, for forming multimaterial layers, and for building geometries that require masks with unconnected sections (e.g., a cylindrical mask has two sections, and the center circle section is not connected to the surrounding section). Automation issues are discussed in Section 4 below.

3. Process Issues: Steel-Based Spraying

To be suitable as a manufacturing process, thermal spray shape deposition must be able to deposit a variety of materials that exhibit good mechanical properties. Post-processing of finished shapes, by hot isostatic pressing for example, can improve mechanical properties. However, such post-processing of three-dimensional sprayed shapes is in general difficult and costly. In contrast, the flat-top geometry of the growing structures in the MD* process creates unique opportunities to enhance material properties at intermediate stages of fabrication.

Consider the problems associated with shape depositing steel. First, there is the choice of support material. The primary function of the support layers in shape deposition processes is to provide surfaces upon which any undercuts of the growing part shape can be built. In a thermal spray approach, the sprayed material also requires a surface, or substrate, to which it can adhere. As the sprayed molten material impinges on the substrate, it solidifies and cools, causing residual stress to accumulate, layer by layer, in the deposited material. The stress field can cause shape distortion and may ultimately lead to delamination of the deposited material from the underlying substrate. Although residual stress is not a problem with zinc deposition, it is particularly

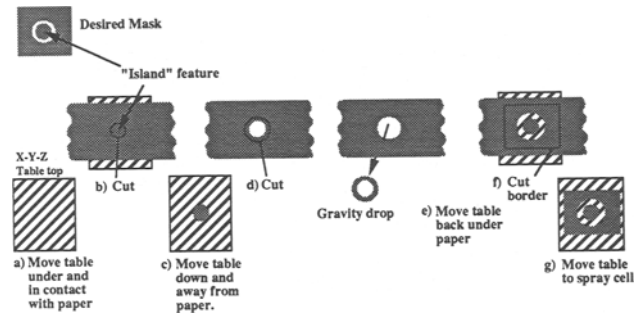

Figure 7 Mask cutting sequence.

problematic for materials with a high elastic modulus such as steel.

A support material must allow the sprayed steel to adhere and must later "release" the completed steel part. Low melting point tin alloys appear to satisfy these requirements based on experience with use in a process for building sprayed steel tooling.^[10] In that process, steel is sprayed onto preformed patterns made with a 60/40 tin/bismuth alloy such as Cerrocast (Cerro Metal Products Co., Bellefonte, PA). The sprayed steel bonds locally to the alloy by superficially melting and abrading a very thin layer of the alloy surface. The steel is backed with tooling epoxy, and the low-melting-point alloy is then removed at approximately 175 °C (350 °F).

In MD*, the support material may also be deposited by a thermal spray process. The sequence of operations required to build a complete layer, including steel with surrounding support, would require two separate masks. A layer of steel would be deposited and shaped with the first mask; the complete mask would then be removed. The next step would be to mask off the steel with a second complementary mask and spray the support material. The complementary mask would then be removed. This sequence would be repeated for each layer. When all layers have been deposited, the support material would be melted away. Other possible strategies for placing support material are suggested in Ref 11. Paper masks and tin alloy support materials are applicable for arc spraying; their use for plasma spraying is currently being evaluated.

While the sprayed steel bonds with the tin alloy, the steel will still warp. Maintaining the part at an elevated temperature during spraying to control residual stress is not feasible because of the relatively low melting temperatures of the support and masking materials. Shot peening of the sprayed material imparts a compressive load, which countered the tensile load resulting from residual stress. Although the ability to uniformly control stress by peening is difficult to achieve with three-dimensional geometries, the planar geometry of this layered approach significantly simplifies the problem. A shot peener could be incorporated into an automated system topeen the flat layers at intermediate stages of the building process (e.g., after every ~0.25 mm, or ~0.010 in. of material is deposited). Shot peening would provide other significant benefits such as improving fatigue resistance and reducing porosity.^[12] As an additional advantage, the peening could remove the burrs around the mask borders.

Another benefit of the flat-top geometry would be to facilitate the use of shrouded spraying to control oxide content. The

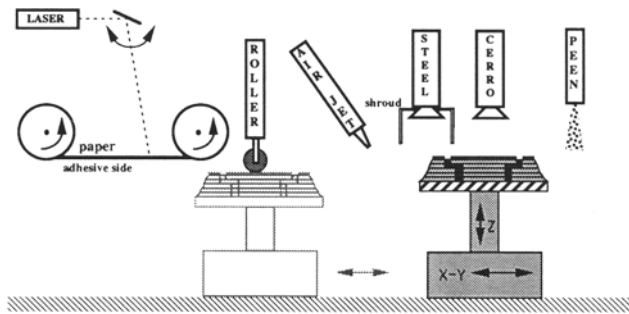

Figure 8 MD* system configuration.

shrouds, which contain the inert shielding and atomization gases to prevent entrainment with surrounding air, could be placed on the spray torches and positioned just above the flat substrate surface.

4. Automation Issues

Automation is one of several challenges to be addressed to create a practical MD* system. Although an automated system has yet to be built, several candidate system configurations are feasible. One possible configuration is shown in Fig. 7. The system consists of several cells, and the workpiece would be carried from cell to cell by a set of high-speed *x-y-z* translational stages. The first cell is a mask-making station where masking material, such as pressure-sensitive paper, is fed on rolls and cut with a CO₂ laser. This cell also includes a roller to press the mask firmly onto the workpiece. The second cell consists of the thermal spray sources such as arc or plasma spray systems. In the example, one source is used for depositing the primary material, such as steel, and another is used for depositing the support material, such as Cerrocast.

One challenging problem is to automate the mask removal reliably after deposition. Mask removal is being investigated. Preliminary experimentation has shown that aiming a jet of air at an acute angle to the mask, to “catch” the mask edges, can blow them off. Another possibility is to use an abrasive wheel to remove them. The final cell, for shot peening, would require an integral vacuum capability to contain and to recirculate the shot. The entire system could be housed in a low-pressure vacuum chamber to control oxide formation and porosity; however, this would be expensive. Placing the system in an enclosed box flooded with inert gas may be a practical alternative at the cost of higher porosity and oxide content in the deposited metal. Another practical alternative to consider is the use of shrouds as described above.

Another issue is how to make the masks with “island” features (*i.e.*, masks with unconnected regions such as the center circle required for masking off a cylinder). One strategy for making such a mask and the steps for fabricating a layer are described below.

To cut masks (see Fig. 7 and 8): move the work table/substrate surface under the rolled out masking material with the surface of the substrate, adjusted by the *z*-stage, below the surface of, and not touching, the adhesive paper. Second, raise the sub-

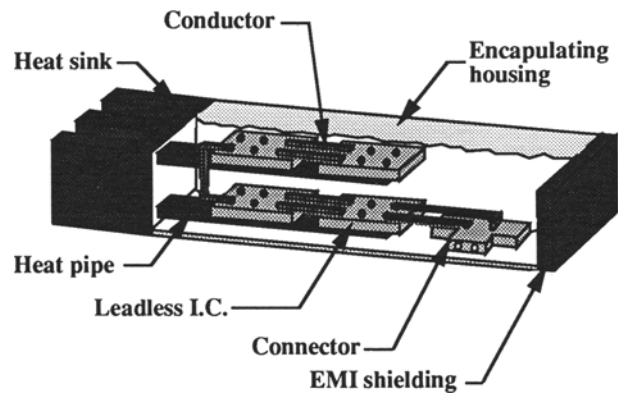

Figure 9 Integrated electronic/mechanical package.

strate until it contacts the adhesive. Laser-cut the “island” feature. Move the work table down and out from under the roll; the “island” feature mask section remains on top of the substrate. Laser-cut the non-island feature; this section drops out by gravity. Move the substrate back under the paper, as described above. Laser-cut the mask border. Move the work table down and out from under the masking station and advance it to the roller station where the masks are pressed firmly in place with the roller.

Advance the work table/substrate to the steel spray station, and spray the steel by moving the *x-y* stages in an appropriate trajectory relative to the steel spray torch. Advance the work table/substrate under the air jet to blow off the mask. Repeat the procedures required to mask and cut an island feature described in the paragraph above, and mask off the steel section just deposited. Advance the work table/substrate to the Cerrometal sprayer and deposit the support layer. Advance the work table/substrate under the air jet to blow off the mask. After every ~0.5 mm (~0.020 in.) of material buildup, advance the substrate to the peening station and shot peen the surface to relieve residual stress.

At this stage of research, it is difficult to accurately predict the build rate of the system described above. Many factors are involved including part geometry and the materials being deposited. As a “back-of-the-envelope” estimate, assume that a complete 0.125-mm (0.005-in.) layer would require 1 min to build. Then the build rate would be 7.5 mm/h (0.3 in./hr). Such a rate would be suitable for rapid prototyping applications. To increase throughput, one could use arrays of torches to scan a layer in a single pass and one could also build multiple parts at one time by defining multiple parts with each mask.

5. Novel Applications

MD* was envisioned to address the challenge of rapidly creating functional prototype parts directly from CAD models. It has the potential to go beyond prototyping applications to create novel structures that would not be feasible with conventional manufacturing processes. For example, complexly shaped composites could be formed because of the versatility of thermal spraying to deposit a wide variety of materials including composites and laminates of metals,¹¹³ plastics, and ceramics.

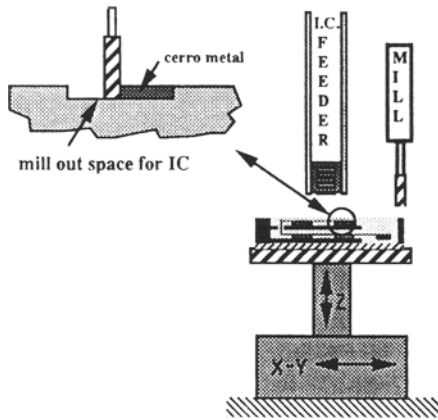

Figure 10 Additional MD* cells for electronic/mechanical packaging applications.

Novel assemblies are also feasible because masking allows selective material deposition within each layer. Therefore, different components can be formed and embedded in a single structure. For example, the fabrication and assembly of completely encapsulated electronic/mechanical structures, such as computer packages, can be integrated into a single process. Components such as heat pipes, heat sinks, EMI shields, and conductors could be sprayed in place, whereas other discrete components such as chips and external connectors could be embedded in the growing sprayed encapsulating package.

Figure 9 is an example of an electronic package that could be produced with the additional MD* system stations (Fig. 10) for integrated circuit (IC) insertion and milling operations. The sprayed components include copper conductors, heat sinks, heat pipes, zinc shielding, and a plastic encapsulating package. For this particular configuration, a wax or Cerrometal support structure could be used.

The steps for fabricating such a package, as shown in Fig. 11, are as follows. The first "n" layers forming sections of the heat sink, housing, EMI shielding, and Cerrocast support are deposited. For example, if the layer deposition thickness is 0.125 mm (0.005 in.) and the height of the deposited structure is 2.5 mm (0.1 in.), then $n = 20$ layers. Separate masks are required for each material for each layer. The layer borders may be staggered, as shown in the insert, to enhance mechanical adhesion between adjacent materials within a layer. A heat pipe is built while continuing to deposit heat sink, housing, and EMI shield. The primary material is deposited, as well as the sacrificial material such as wax or Cerrometal. In these layers, support material is also used to reserve space for the discrete components, as described below. The sacrificial material is milled out to make space for the integrated circuits and external connectors. These components are then inserted in the package. Conductors are then deposited and the process of building the heat sinks, etc., is continued. Multilayer interconnect conductors are built up and the process continues. The previous steps are repeated to fabricate additional component layers. After the part is completed, the wax is removed using localized heating or machining.

Integrated electronic/mechanical packages would have several advantages relative to those manufactured with conventional processes. They should exhibit high reliability due to the

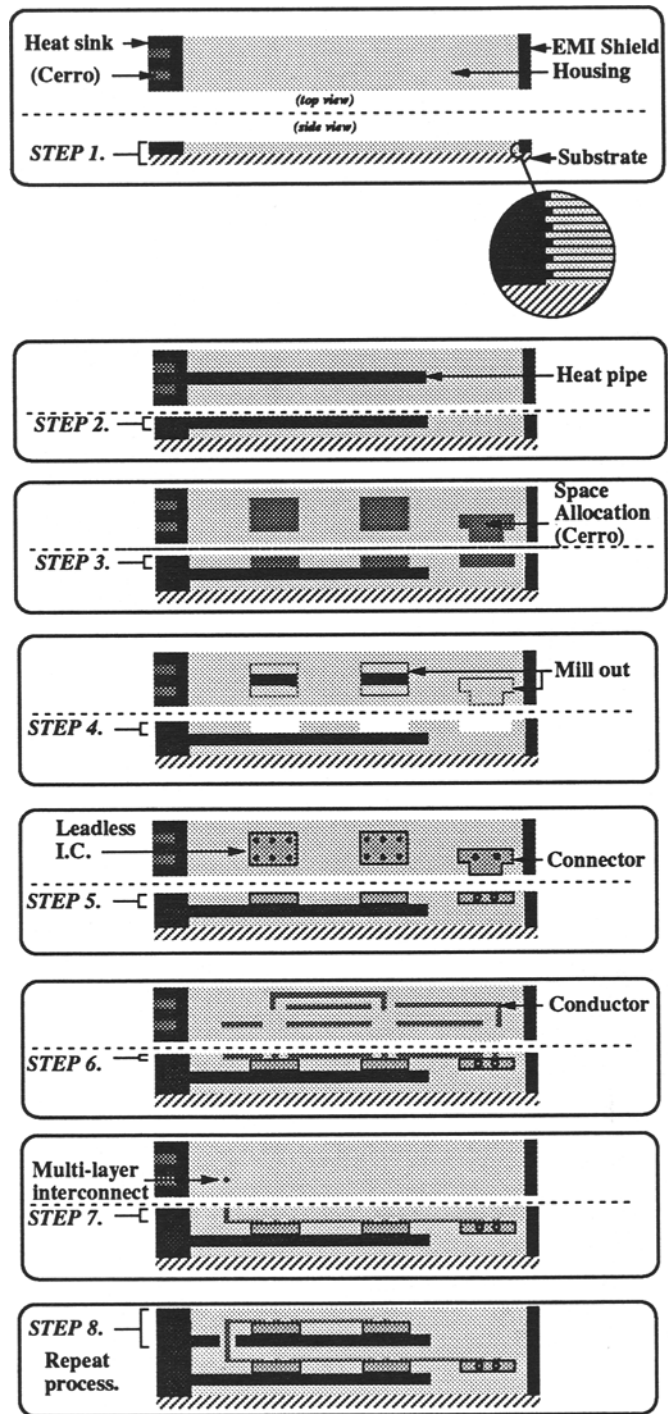

Figure 11 Fabrication steps.

elimination of discrete board interconnects and the elimination of a final assembly process. The intimate and absolute mechanical couplings of the encapsulated connections to integrated circuits should withstand high G forces. There should be efficient thermal management, because thermal conduits with arbitrarily complex shapes can be fabricated for the specific application

and package geometry. Very dense packaging systems could be fabricated because discrete mechanical interconnects and boards are eliminated. Arbitrarily shaped packages can be fabricated to fit nonstandard volumes and to accommodate the stringent space allocation limits associated with aerospace structures, for example. In addition, there should be excellent corrosion resistance due to total encapsulation.

6. Conclusion

The MD* process addresses the issue of spray forming net-shape parts with arbitrarily complex geometries. Although the prototype system described in this article demonstrates the feasibility of this approach, further research is required to develop systems and processes that will quickly create functional parts with good mechanical properties. The MD* concept provides a framework upon which to build such systems. A process is envisioned that will go beyond rapid prototyping applications to creating composite, multimaterial structures that are not feasible with conventional manufacturing technologies.

Acknowledgments

The MD* system and prototype parts were built with the help and effort of several dedicated members of the Shape Deposition Laboratory. The authors wish to thank Martin Fasching, Kevin Hartmann, Robert Merz, Larry Schultz, David Sealfon, and David Thuel for their significant contributions.

References

1. L. Weiss, E.L. Gursoz, F.B. Prinz, P.S. Fussell, S. Mahalingham, and E.P. Patrick, "A Rapid Tool Manufacturing System Based on Stereolithography and Thermal Spraying," *Manufact. Rev.*, 3(1), 40-48 (1990).
2. D.L. Bourell, J.J. Beaman, H.L. Marcus, and J.W. Barlow, "Solid Freeform Fabrication: An Advanced Manufacturing Approach," *Proc. Solid Freeform Fabrication Symposium*, The University of Texas at Austin, Aug 6-8, 1-7 (1990).
3. S. Ashley, "Rapid Prototyping Systems," *Mech. Eng.* 113(4), 34-43 (1991).
4. T.E. Doyle, "Shape Melting Technology," *Proc. Nat. Conf. Rapid Prototyping*, sponsored by the Rapid Prototype Development Laboratory, Center for Advanced Manufacturing, University of Dayton, Dayton, June 4-5, 55-62 (1990).
5. H. Herman and S. Sampath, "Plasma Spray Forming of Free-Standing Shapes," *Proc. 2nd Plasma-Technik Symp.*, sponsored by Plasma Technik, Inc., Luzern, Switzerland, May 5-7, 63-73 (1991).
6. D. Hauber, "Automated Fabrication of Net Shape Microcrystalline and Composite Metal Structures Without Molds," *Proc. NSF 14th Conf. Production Research Technol.*, University of Michigan, Oct 6-9 461-466 (1987).
7. L.E. Weiss and F.B. Prinz, "Solid Freeform Fabrication by Thermal Spray Shape Deposition," *Proc. 1992 ASM Int. Thermal Spray Conf.*, Orlando, June 1-5 (1992).
8. R. Merz, F.B. Prinz, and L.E. Weiss, "Planning Mask Cutting for Thermal Spray Spray Deposition," Technical report EDRC 24-73-91, Carnegie Mellon University, Pittsburgh, PA (1991).
9. M.M. Fasching, L.E. Weiss, and F.B. Prinz, "Optimization of Robotic Spray Trajectories for Thermal Spray Shape Deposition," Technical report EDRC 24-74-91, Carnegie Mellon University, Pittsburgh, PA (1991).
10. L.E. Weiss and L. Schultz, U.S. patent 5,079,974, "Sprayed Metal Dies" (1991).
11. L.E. Weiss and F.B. Prinz, "A Conceptual Framework for a 'Masks & Deposits' Thermal Spray Shape Deposition System," *Proc. DARPA Workshop Manufact.*, Salt Lake City, Feb (1991).
12. K.I. Anson *et al.*, "Use of the Shot Peening Process for Surface Modification of Thermal Sprayed Coatings," *Proc. ASM 4th Nat. Thermal Spray Conf.*, Pittsburgh, May 4-10, 138-145 (1991).
13. P.S. Fussell, H.O.K. Kirchner, F.B. Prinz, and L.E. Weiss, "Controlling the Microstructure of Arc Sprayed Shells," *Proc. Solid Freeform Fabrication Symp.*, The University of Texas, Austin, Aug 12-14, 213-235 (1991).